

DETAIL A
SCALE 1 : 2

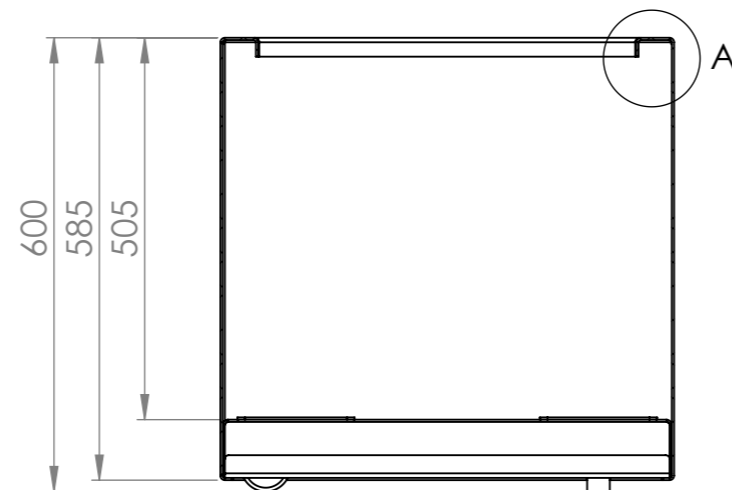

SECTION B-B

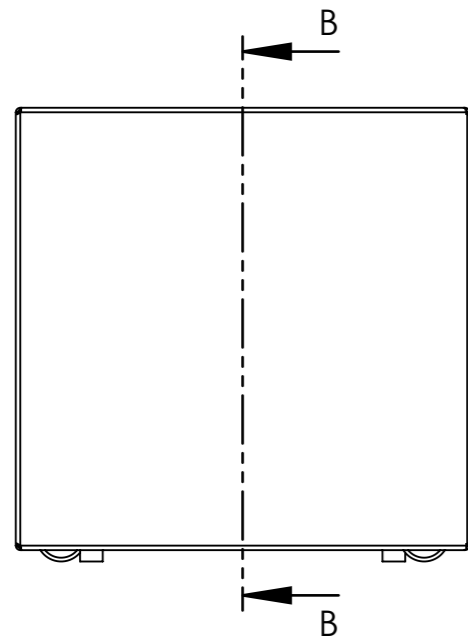
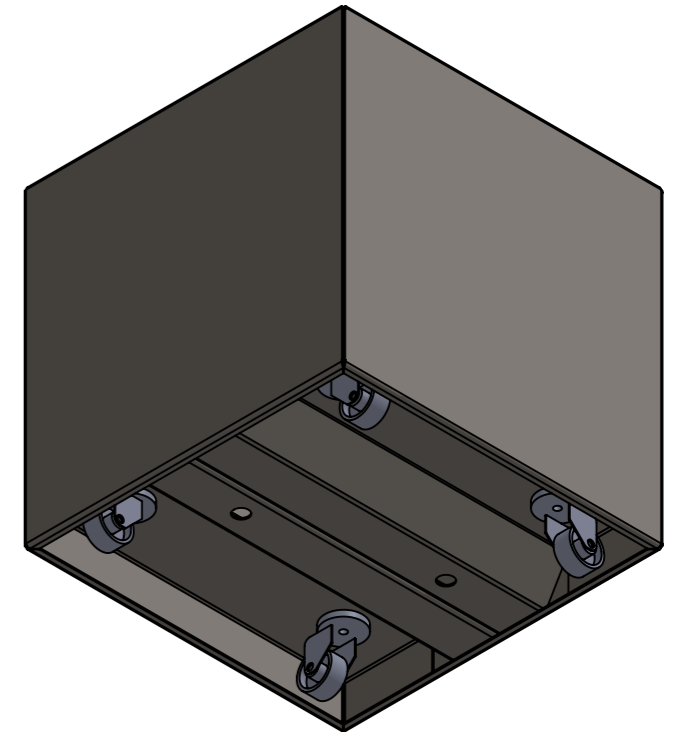
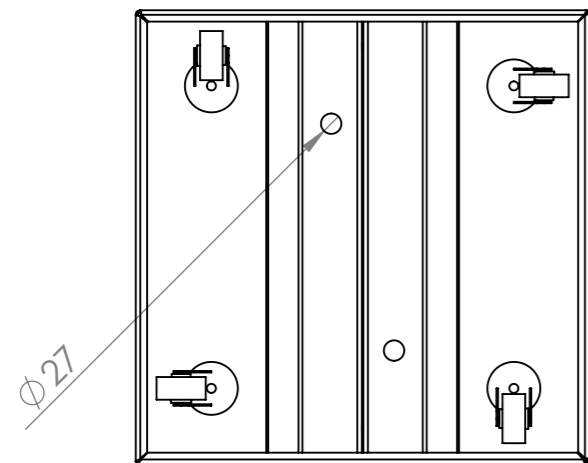
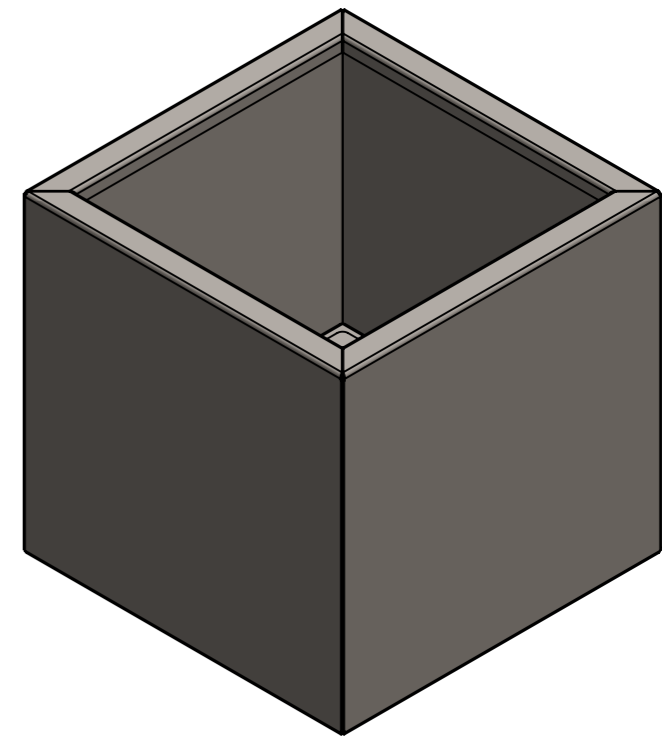

DRAWN	Luuk van den Heuvel	DATE	18-2-2021		TITLE:	3mm Aluminum	
REVISION	Pleuni Bongers	DATE	26-5-2021		Drawing:	AFWL 8	A3
		Liessentstraat 4, 5405 AG Uden (NL). t 0031 (0)413 - 27 41 68. e info@adezz.com, i www.adezz.com		Color:	Mass (kg):	18.25	SCALE:1:10
					SHEET 1 OF 5		